

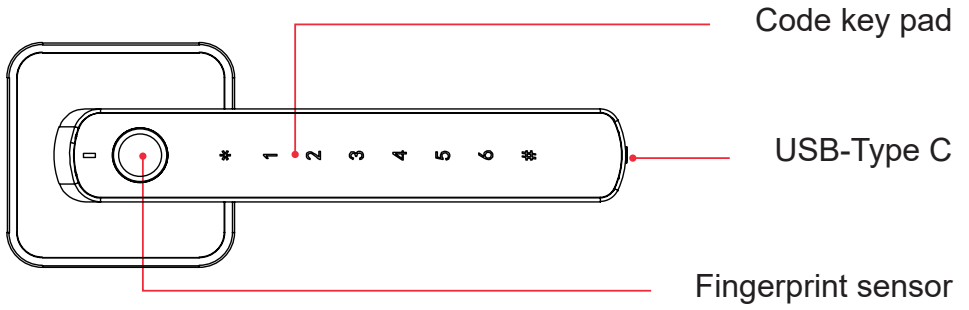

Rosé

User's Guide

Outside Lever



Inside Lever

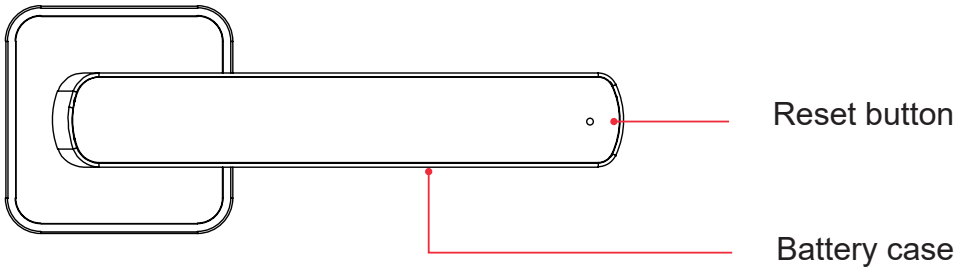

Rosé

Digital Door Lock

1. There are two 6 to 10 digit master codes in the Rosé lock.
2. There are 200 user fingerprints/codes available on the Rosé lock.
3. User codes can be 6 to 10 digits.
4. The lock is powered by 3 AAA alkaline batteries (included).
A USB-Type C port is at the end of the outside handle for emergency power supply.
5. The Rose lock has three possible modes:
Standard mode: single code/fingerprint needed to unlock
Passage mode: outside lever unlock for free access
Dual user mode: two codes or fingerprints needed to unlock

Installation Instructions

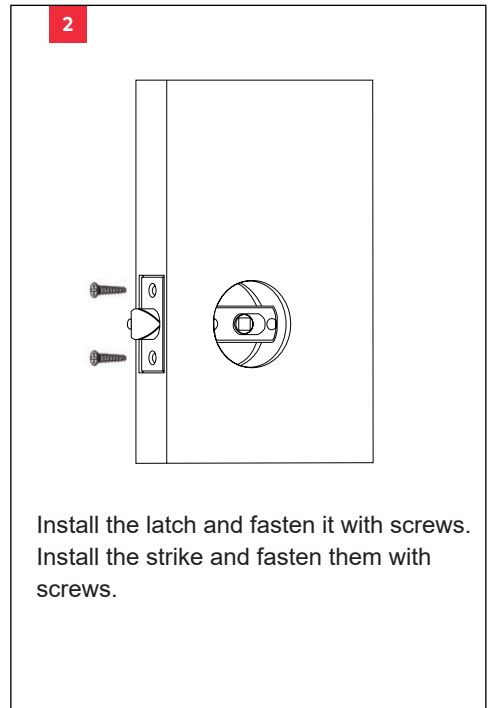
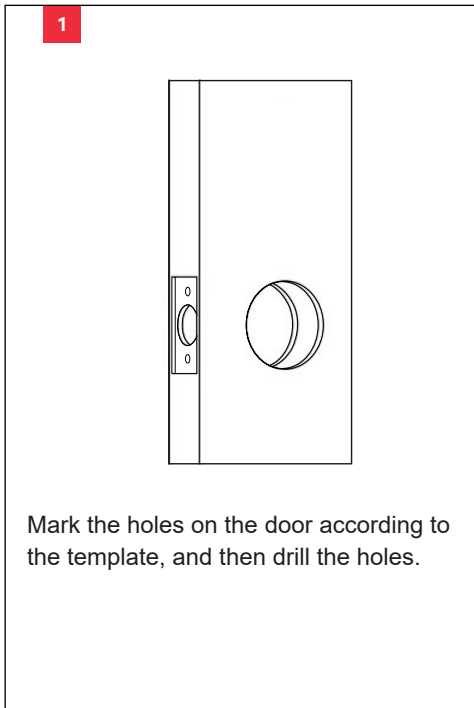

3

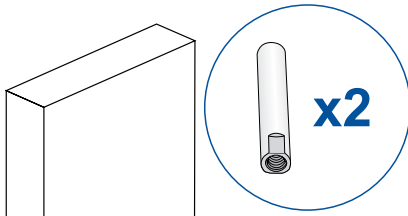

Screw the two (2) posts (groove side) onto the small black screws attached to the inside face of the outside lever. Place the outside lever onto the door ensuring posts go through latch.

4

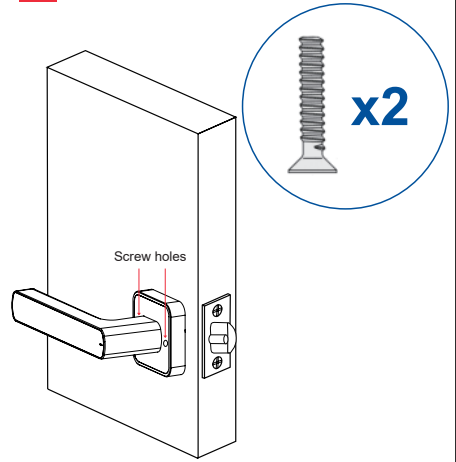

Place the inside lever onto the door. Line up holes with posts, then using the two (2) screws provided, secure the inside and outside levers onto the door.
Note: Do not overtighten the screws.

5

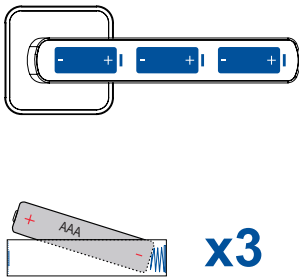

Use the screw driver provided to unscrew the battery cover located in the inside handle. Then install the batteries (negative terminal going first). Cover the batteries.

6

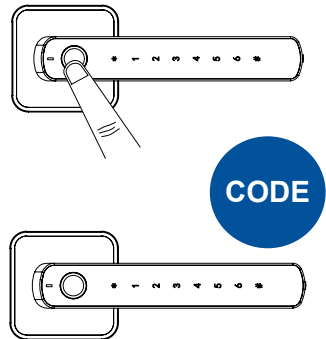

With door open try to unlock the lock and make sure the installation was successful. In factory default mode, the lock will unlock with any code or any finger print.

1. Register Master Codes

1.1 Register Master Code for a brand new lock or after factory reset

The following procedure is only required when the Rosé lock is brand new or after the lock has been factory reset.

Note: The programming of user codes or fingerprints cannot be made until a new master code has been created.

Note: Keep the door open while master codes are being created.

Step 1

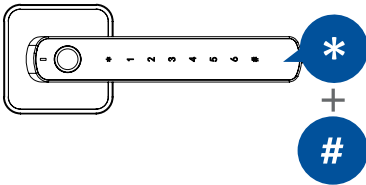

- Wake up the key pad by touching any of the numbers. Press * and then #
- Audible message - “enter a new master user information”

Step 2

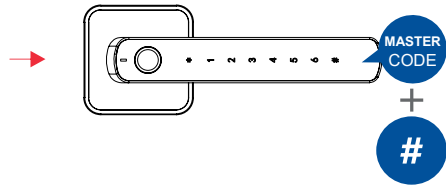

- Enter a new 6 to 10 digit master code
- Press #
- Audible message - “enter it again”
- Enter the new master code again
- Press #
- Audible message - “successful”
- Press * to exit the menu

1. Register Master Codes

1.2 Register Second Master Code (optional)

Note: Keep the door open while master codes are being created.

Step 1

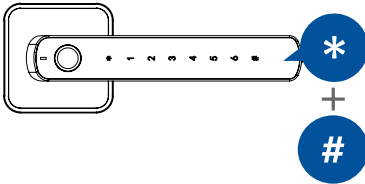

- Wake up the key pad by touching any of the numbers. Press * and then #
- Audible message - "enter the master user information"

Step 2

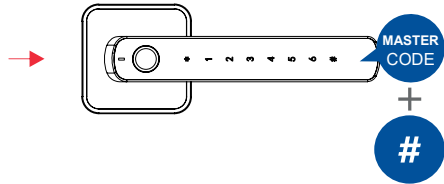

- Enter the master code created in step 1.1
- Press #

Step 3



- Audible message - "1 add admin"
- Press 1 for master code registration"
- Audible message - "enter the lock information"

Step 4

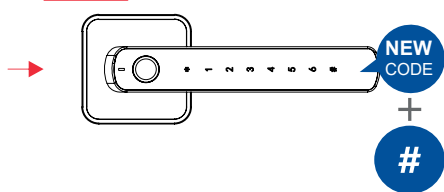

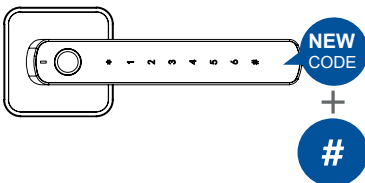

- Enter a new 6 to 10 digit master code, and confirm with #

Step 5



- Audible message - "enter it again"
- Enter the new 6 to 10 digit master code, and confirm with # to finish
- Press * twice to leave the menu

 You have to register a master code in the lock first, so that you can register the user codes in the lock.

 Once the operation is finished, please try to unlock the lock to confirm the operation is successful.

2. Register Users

2.1 Register User Fingerprint

Please make sure a master code is registered in the lock.

Step 1

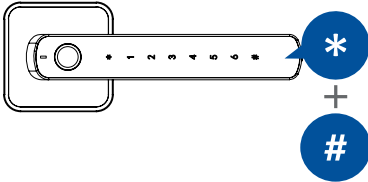

- Wake up the key pad by touching any of the numbers. Press * and then #
- Audible message - "enter the master user information"

Step 2

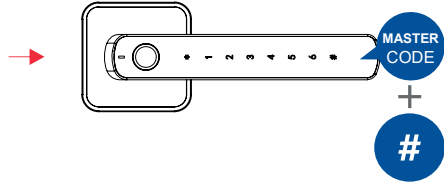

- Enter the 6 to 10 digit master code
- Press #

Step 3

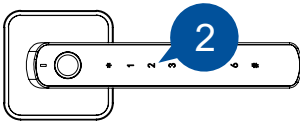

- Audible message - "2 add user"
- Press 2 for user registration
- Audible message - "enter the lock information"

Step 4

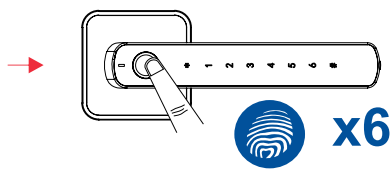

- A. Place the finger on the sensor
- B. Audible message - "enter again"
- C. Remove finger
- Repeat steps A,B & C six times until audible message is heard
- Audible message - "successful"
- Press * twice to leave the menu



Once the operation is finished, please try to unlock the lock using the added finger to confirm the operation is successful.



If a wrong finger print is placed 5 times in a row the lock will go into lockout mode for 5 minutes.

2. Register Users

2.2 Register User Codes

Please make sure a master code is registered in the lock.

Step 1

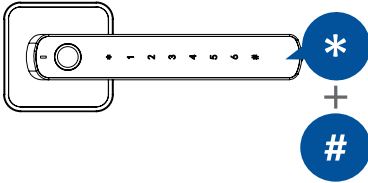

- Wake up the key pad by touching any of the numbers. Press * and then #
- Audible message - "enter the master user information"

Step 2

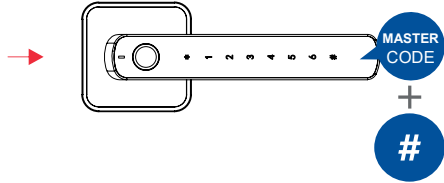

- Enter the 6 to 10 digit master code
- Press #

Step 3

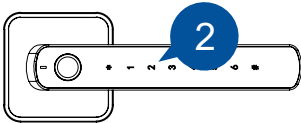

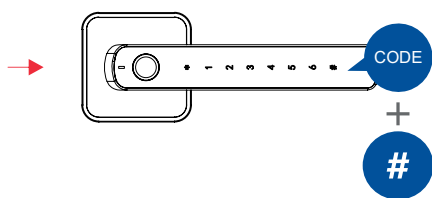

- Audible message - "2 add user"
- Press 2 for user registration
- Audible message - "enter the lock information"

Step 4



- Enter the new user code and press #
- Audible message - "enter it again"
- Enter the new user code and press # to register
- Audible message - "successful"
- Press * twice to leave the menu

 User codes can be 6 to 10 digits.

 Once the operation is finished, please try to unlock the lock using a code to confirm the operation is successful.

 If a wrong code is entered 5 times in a row the lock will go into lockout mode for 5 minutes.

3. Delete User Codes and Fingerprints

Please make sure the master code is registered in the lock.

Step 1

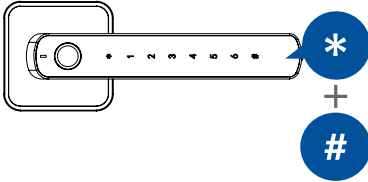

Step 2

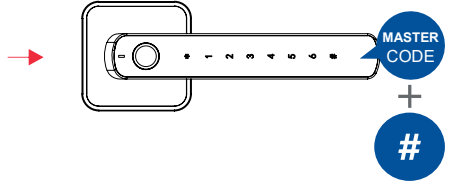

- Wake up the key pad by touching any of the numbers. Press * and then #
- Audible message - "enter the master user information"

- Enter the 6 to 10 digit master code
- Press #

Step 3

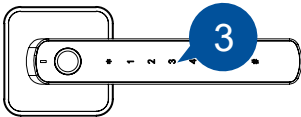

- Audible message - "3 delete user"
- Press 3 to delete user codes/fingerprints

To delete a single user follow **Step 4** on page 10

To delete all users follow **Step 5** on page 11

3. Delete User Codes and Fingerprint continued...

Use this option to delete a single user

Step 4

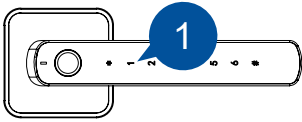

Note: Go to step 4a to delete single user or 4b to delete single fingerprint

- Audible message - “1 to delete a single user”
- Audible message - “delete user, enter the lock information”

Step 4a Delete a single user code

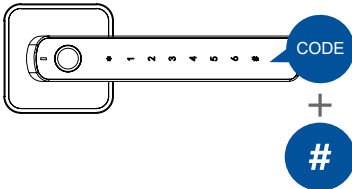

- Enter the user code and press # to delete it
- Audible message - “delete user, press # key to confirm”
- Press # to confirm
- Audible message - “successful”
- Press * three times to leave the menu

Step 4b Delete a single fingerprint

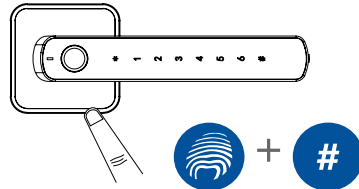

- Place the finger on the sensor to delete the finger print
- Audible message - “delete user, press # key to confirm”
- Press # to confirm
- Audible message - “successful”
- Press * three times to leave the menu

3. Delete User Codes and Fingerprint continued...

Use this option to delete all users

Step 5

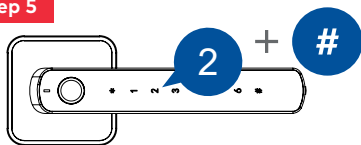

- Audible message - “2 to delete all normal users”
- Press 2 to delete all users (fingerprints and codes)
- Audible message - “delete users, press # key to confirm”
- Press # to confirm
- Audible message - “successful”
- Press * twice to leave the menu

 *Master codes are still in the lock. Reset to factory default to delete master codes.*

 *Once the operation is finished, please try to unlock the lock to confirm the operation is successful.*

4. Passage Mode

When the lock is required to unlock frequently, set the lock in passage mode.

Step 1

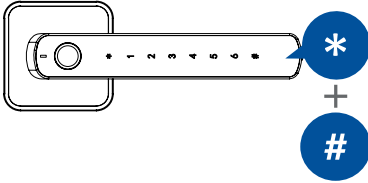

Step 2

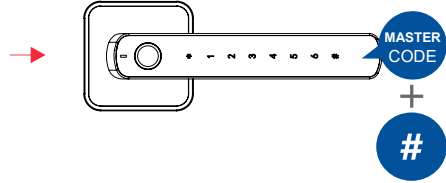

- Wake up the key pad by touching any of the numbers. Press * and then #
- Audible message - “enter the master user information”

- Enter the 6 to 10 digit master code
- Press #

Step 3

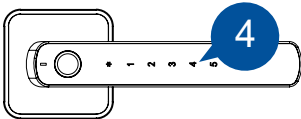

- Audible message - “4 system settings”
- Press 4 for system settings

Step 4

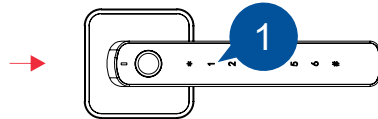

- Audible message - “passage mode”
- Press 1 for passage mode

Step 4a

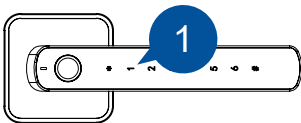

- Audible message - “1 normal”
- Press 1 to disable passage mode
- Audible message - “successful”
- Press * three times to leave the menu

Step 4b

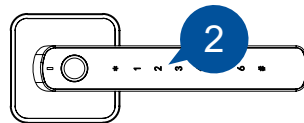

- Audible message - “2 manual mode”
- Press 2 to enable passage mode
- Audible message - “successful”
- Press * three times to leave the menu

Note: Passage mode will start the next time a user code/fingerprint is used

5. Dual User Mode

To activate the dual user mode a combination of either two different codes or two different fingerprints or a code and a fingerprint is needed.

Step 1

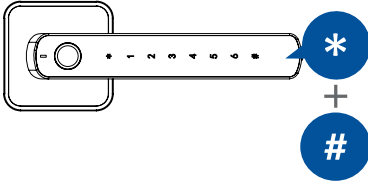

Step 2

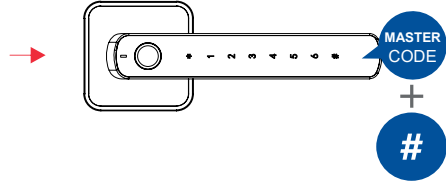

- Wake up the key pad by touching any of the numbers. Press * and then #
- Audible message - “enter the master user information”

- Enter the 6 to 10 digit master code
- Press #

Step 3

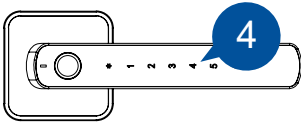

- Audible message - “4 system settings”
- Press 4 for system settings

Step 4

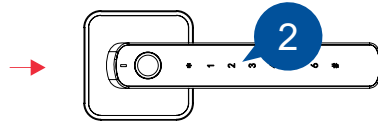

- Audible message - “2 verification mode”
- Press 2 for dual user mode or verification mode

Step 4a

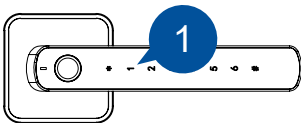

- Audible message - “1 single mode”
- Press 1 to enable single user code/ fingerprint unlocking
- Audible message – “successful”
- Press * three times to leave the menu

Step 4b

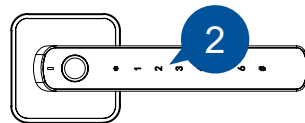

- Audible message - “2 double mode”
- Press 2 to enable double user codes and/ or fingerprint unlocking
- Audible message – “successful”
- Press * three times to leave the menu

 Master codes override the double unlocking mode.

Note: Once a first credential has been entered, the Rosé will ask for the second credential to unlock

6. Volume Settings

Please make sure the master code is registered in the lock.

Step 1

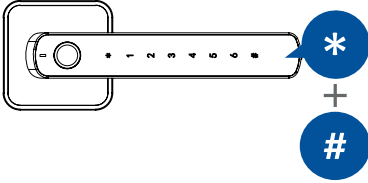

- Wake up the key pad by touching any of the numbers. Press * and then #
- Audible message - “enter the master user information”

Step 2

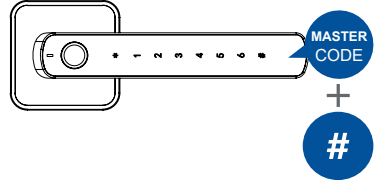

- Enter the 6 to 10 digit master code
- Press the #

Step 3

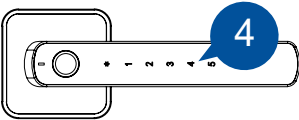

- Audible message - “4 system settings”
- Press 4 for system settings

Step 4

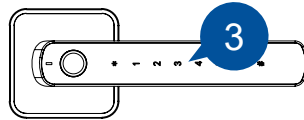

- Audible message - “3 volume settings”
- Press 3 for volume settings

Step 4a

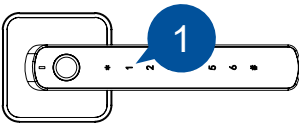

- Audible message - “1 volume down”
- Press 1 repeatedly until desired volume is reached or until 3 beeps are heard (the lock can't reduce the volume anymore)
- Press * three times to leave the menu

Step 4b

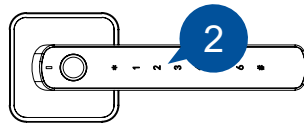

- Audible message - “2 volume up”
- Press 2 repeatedly until desired volume is reached or until 3 beeps are heard (the lock can't increase the volume anymore)
- Press * three times to leave the menu

Menu summary

Creating a master code after factory reset or brand new lock



Adding a second master code (optional)



Creating a user code/fingerprint

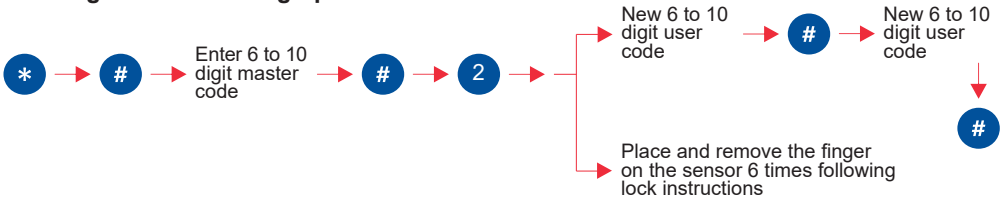

Deleting user code/fingerprint

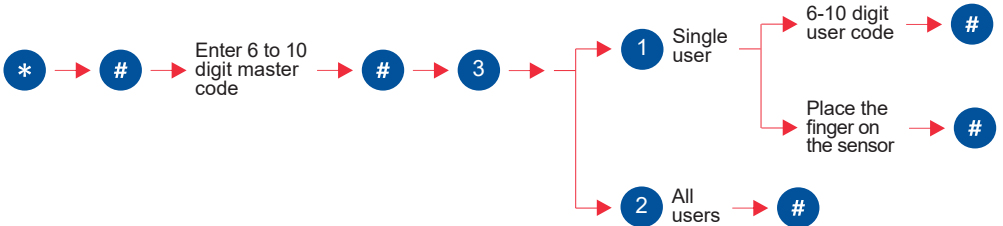

System settings

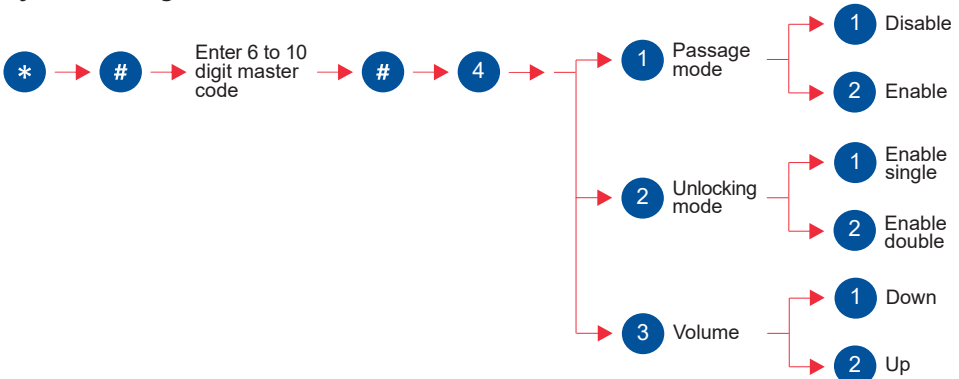



Fitting Template

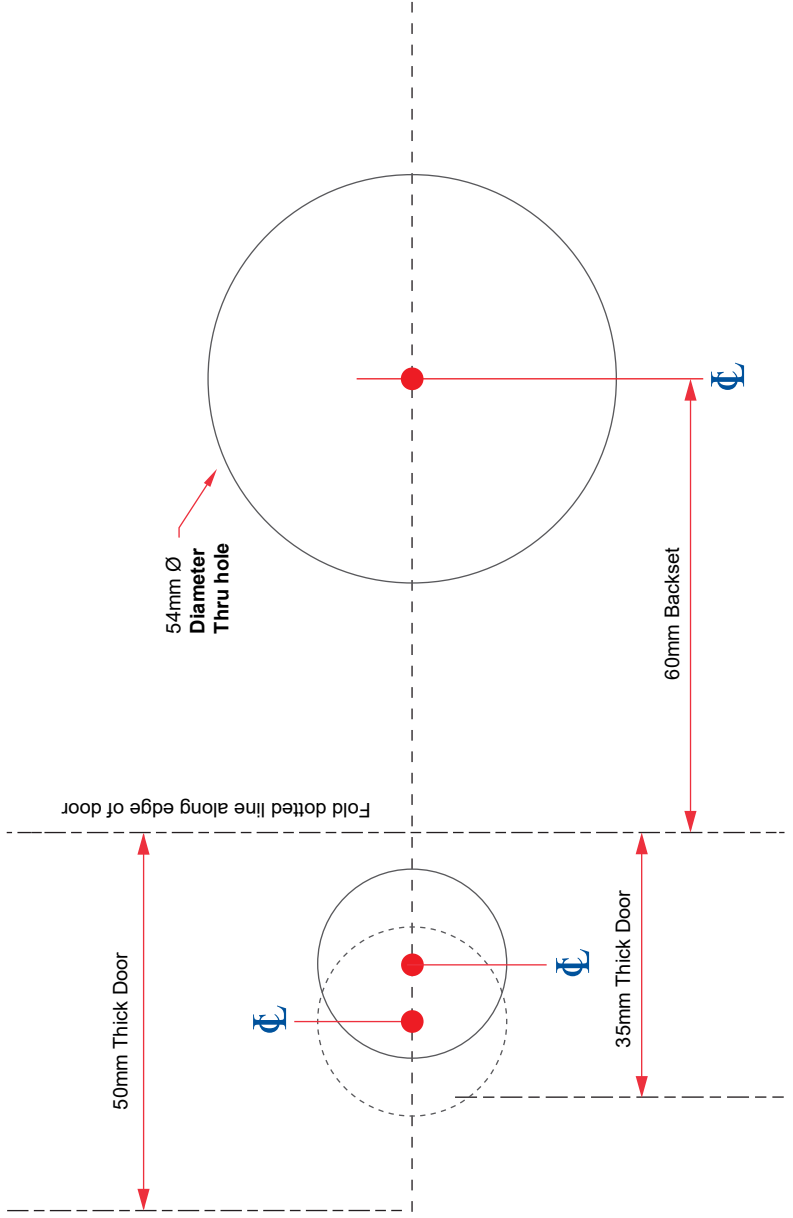

BACK OF FITTING TEMPLATE



WARRANTY

In Australia, our goods come with guarantees that cannot be excluded under the Australian Consumer Law. You are entitled to a replacement or refund for a major failure and for compensation for any other reasonably foreseeable loss or damage. You are also entitled to have the goods repaired or replaced if the goods fail to be of acceptable quality and the failure does not amount to a major failure.

dormakaba Australia Pty Ltd (ABN 14 067 969 466) trading as dormakaba of 12-13 Dansu Ct, Hallam, Victoria 3803 (dormakaba) provides the following warranty in relation to its digital suite (Products).

The benefits of this warranty are in addition to any rights and remedies imposed by Australian State and Federal legislation that cannot be excluded. Nothing in this warranty is to be interpreted as excluding, restricting or modifying any State or Federal legislation applicable to the supply of goods and services which cannot be excluded, restricted or modified. dormakaba warrants that, subject to the conditions, exclusions and limitations below, the Products will be free from defects for a period of 1 year.

1. If a defect covered by warranty appears before the end of the Warranty Period, then dormakaba will, in its sole discretion, either:
 - (a) replace or repair the Product or the defective part of the Product free of charge; or
 - (b) refund the price of the Product; or
2. dormakaba reserves the right to replace defective parts of the Product with parts and components of similar quality, grade and composition where an identical part or component is not available.
3. Products presented for repair may be replaced by refurbished goods of the same type rather than being repaired. Refurbished parts may be used to repair the Products.

WARRANTY CLAIMS

1. Any claim for warranty must be made, by contacting the store where the product has been purchased from, at the earliest stage that the defect becomes obvious to enable prompt action and to avoid further damage and must be made no later than 1 month from the defect/date of repair becoming obvious.
2. Any warranty claim must be accompanied by appropriate documentation which stipulates the date of the installation, the invoice number, the purchaser name and address, and the alleged defect.
3. The purchaser must make the Product or workmanship available to dormakaba for inspection and testing. If dormakaba finds no fault in the Product or its workmanship, then the purchaser must pay dormakaba's usual costs of service work, inspection and testing.
4. Warranty work will be conducted by dormakaba during normal working hours (8.00am to 5.00pm Monday to Friday).

EXCLUSIONS

1. The purchaser acknowledges that the Products are not indestructible, and that some care in installation and maintenance is necessary. No liability is accepted for, and this warranty does not apply to:
 - (a) any damage caused by misuse or failure to adhere to the manufacturer's selection and installation specifications, instructions or recommendations;
 - (b) fair wear and tear;
 - (c) defects arising due to the installation of the Products where the Products were not installed by dormakaba or its agents;
 - (d) any damage or defects caused to the structures the Products are installed in, where the Products were not installed by dormakaba or its agents;
 - (e) damage caused by circumstances beyond dormakaba's control;
 - (f) any damage or defects within acceptable industry variances;
 - (g) Products that have been used other than for the purpose for which they were designed;
 - (h) damage caused by exposure to abnormal conditions, including but not limited to environment, temperature, water, fire, humidity, pressure, stress or similar;
 - (i) defects that arise due to abuse, misuse or neglect;
 - (j) Products that have been modified, built on or repaired;
 - (k) Products that have not been maintained as recommended by dormakaba;
 - (l) maintenance items (which are the responsibility of the purchaser);
 - (m) Products installed, maintained or operated other than in accordance with dormakaba's instructions; and
 - (n) overhaul, replacement or repair works undertaken prior to approval from dormakaba of any warranty claim.

LIMITATIONS

1. dormakaba makes no express warranties or representations other than set out in this warranty.
2. dormakaba reserves the right to alter product specifications and introduce improvements at any time.

dormakaba Australia

Head Office

12-13 Dansu Court

Hallam VIC 3803

T: 1800 675 411

info.au@dormakaba.com

www.dormakaba.com.au

dormakaba New Zealand

Head Office

Building P, 61-69 Patiki Road

Avondale, Auckland 1026

T: 0800 436 762

info.nz@dormakaba.com

www.dormakaba.co.nz